

UH 60

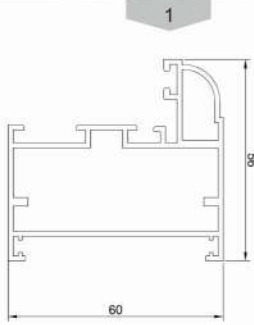

پروفیل فریم
 Frame profile
 Code : 13311
 weight : 1.14 kg/m

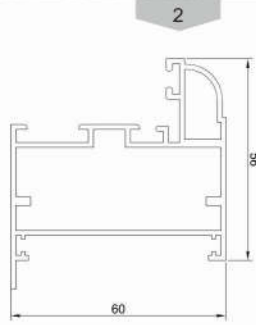

پروفیل فریم
 Frame profile
 Code : 13312
 weight : 1.17 kg/m

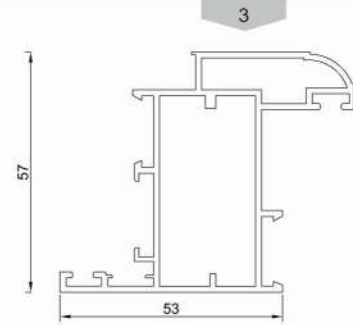

پروفیل لنگه پنجره
 Vent profile
 Code : 13331
 weight : 1.11 kg/m

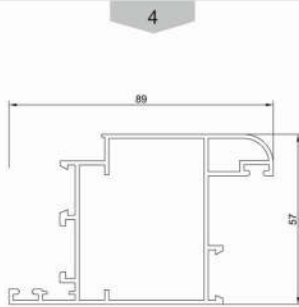

پروفیل لنگه درب
 Vent profile
 Code : 13332
 weight : 1.3 kg/m

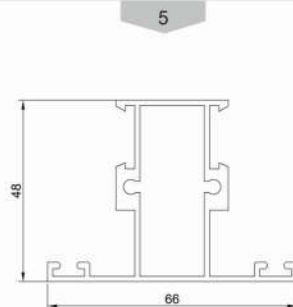

پروفیل سپری
 T profile
 Code : 13341
 weight : 1 kg/m

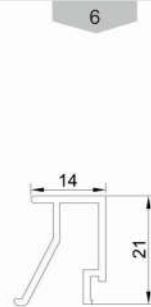

زهوار دو جداره
 Double rickety
 Code : 12351
 weight : 0.22 kg/m

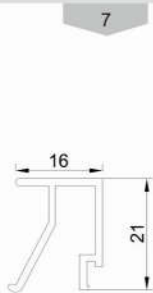

زهوار دو جداره
 Double rickety
 Code : 12352
 weight : 0.23 kg/m



تسمه
 Strap profile
 Code : 10230
 weight : 0.11 kg/m



تسمه
 Strap profile
 Code : 10231
 weight : 0.17 kg/m

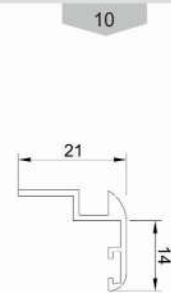

روکوب ۱۴
 Suppressed the binding
 Code : 10021
 weight : 0.2 kg/m

UH 60

11

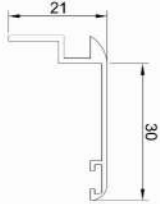

روکوب ۳۰

Suppressed the binding
 Code : 10022

weight : 0.22 kg/m

12

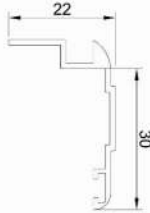

روکوب ۳۰

Suppressed the binding
 Code : 10023

weight : 0.23 kg/m

13

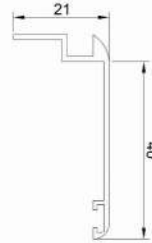

روکوب ۴۰

Suppressed the binding
 Code : 10024

weight : 0.25 kg/m

14



روکوب ۴۰

Suppressed the binding
 Code : 10025

weight : 0.26 kg/m

15

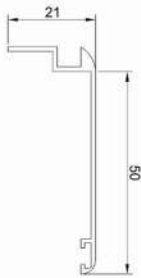

روکوب ۵۰

Suppressed the binding
 Code : 10026

weight : 0.28 kg/m

16



روکوب ۵۰

Suppressed the binding
 Code : 10027

weight : 0.29 kg/m